

**(R) Electromagnetic Compatibility Measurement Procedure for Vehicle Components—
Part 21: Immunity to Electromagnetic Fields, 30 MHz to 18 GHz, Absorber-Lined Chamber**

TABLE OF CONTENTS

1.	Scope	2
1.1	Rationale	2
2.	References	2
2.1	Applicable Publication	2
3.	Measurement Philosophy	3
4.	Test Conditions	3
5.	Test Location	3
6	Test Instrumentation	4
6.1	Field Generating Device	4
6.2	Field Probes	4
6.3	Stimulation and Monitoring of the DUT	4
7.	Test Set-Up – Test Performed with a Ground Plane	5
7.1	Ground Plane	5
7.2	Power Supply and Artificial Network	5
7.3	Location of the DUT	5
7.4	Location of the Test Harness	5
7.5	Location of the Load Simulator	6
7.6	Location of the Field Generating Device (Antenna)	6
8.	Test Set-Up – Test Performed without a Ground Plane	10
8.1	Test Configuration	10
8.2	Field Uniformity Measurement	11
9.	Test Procedure	12
9.1	Test Plan	13

SAE Technical Standards Board Rules provide that: "This report is published by SAE to advance the state of technical and engineering sciences. The use of this report is entirely voluntary, and its applicability and suitability for any particular use, including any patent infringement arising therefrom, is the sole responsibility of the user."

SAE reviews each technical report at least every five years at which time it may be reaffirmed, revised, or cancelled. SAE invites your written comments and suggestions.

Copyright © 2005 SAE International

All rights reserved. No part of this publication may be reproduced, stored in a retrieval system or transmitted, in any form or by any means, electronic, mechanical, photocopying, recording, or otherwise, without the prior written permission of SAE.

TO PLACE A DOCUMENT ORDER: Tel: 877-606-7323 (inside USA and Canada)
Tel: 724-776-4970 (outside USA)
Fax: 724-776-0790
Email: custsvc@sae.org
<http://www.sae.org>

SAE WEB ADDRESS:

SAE J1113-21 Revised OCT2005

9.2	Test Method	13
9.2.1	Field Calibration	14
9.2.2	DUT Test	14
9.3	Test Report	14
10.	Notes	14
10.1	Marginal Indicia	14
Appendix A	(Informative) Artificial Network (AN).....	15
A.1	General.....	15
A.2	AN Impedance	15
Appendix B	(Informative) Remote / Local Grounding.....	17
B.1	DUT Remotely Grounded	17
B.2	DUT Locally Grounded	18
Appendix C	(Informative) Functional Performance Status Classification.....	19

1. Scope

This part of SAE J1113 specifies test methods and procedures for testing electromagnetic immunity (of vehicle radiation sources) of electronic components for passenger cars and commercial vehicles. To perform this test method, the electronic module along with the wiring harness (prototype or standard test harness) and peripheral devices will be subjected to the electromagnetic disturbance generated inside an absorber-lined chamber. The electromagnetic disturbances considered in this part of SAE J1113 are limited to continuous narrowband electromagnetic fields.

Immunity measurements of complete vehicles are generally only performed at the vehicle manufacturer. The reasons, for example, are high costs of a large absorber-lined chamber, preserving the secrecy of prototypes, or the large number of different vehicle models. Therefore, for research, development and quality control, a laboratory measuring method shall be applied by the manufacturers.

Part 1 of SAE J1113 specifies the general, definitions, practical use, and basic principles of the test procedure

1.1 Rationale

The JAN 1988 version of this standard has been revised to incorporate the latest changes in the International Standards ISO 11452-2. A new section has also been added to incorporate the test procedures for performing the test on a non-metallic bench top (including a new requirement for field uniformity).

2. References

2.1 Applicable Publications

The following publications form a part of this specification to the extent specified herein. The latest issue of SAE publications shall apply.

2.1.1 SAE PUBLICATIONS

Available from SAE, 400 Commonwealth Drive, Warrendale, PA 15096-0001.

SAE J1113-1—Electromagnetic Compatibility Measurement Procedures and Limits for Components of Vehicles, Boats (up to 15 m), and Machines (Except Aircraft) (50 Hz to 18 GHz)
SAE J1812—Function Performance Status Classification for EMC Immunity Testing

2.1.2 ISO PUBLICATIONS

Available from ANSI, 25 West 43rd Street, New York, NY 10036-8002.

ISO 11452-1:3rd Edition 2/2005—Road vehicles—Component test methods for electrical disturbances from narrowband radiated electromagnetic energy—Part 1: General and definitions

ISO 11452-2:2nd Edition 10/2004—Road vehicles—Electrical disturbances by narrowband radiated electromagnetic energy—Component test methods—Part 2: Absorber-lined chamber

3. *Measurement Philosophy*

The objective of an absorber-lined chamber is to create an indoor electromagnetic compatibility testing facility. The shielded chamber is lined with absorbing material on as many surfaces in the chamber as possible to minimize reflections and resonance. The design objective is to reduce the reflectivity in the test area to -10 dB or less.

Typical application for this test method is recommended for frequency range of 30 MHz to 18 GHz.

4. *Test Conditions*

Standard test conditions are given in SAE J1113-1 for the following:

- test temperature;
- supply voltage;
- modulation;
- dwell time;
- frequency step sizes;
- definition of test severity levels;
- test signal quality;
- test severity level.

5. *Test Location*

The tests shall be performed in an absorber-lined shielded enclosure. The objective of an absorber-lined shielded enclosure is to create an isolated electromagnetic compatibility test facility. Basically, an absorber-lined shielded enclosure consists of a shielded room with absorbing material on its internal reflective surfaces, optionally excluding the floor. The design objective is to attenuate the reflected energy in the test area by at least 10 dB compared to the direct energy.

6. Test Instrumentation

Radiated electromagnetic fields are generated using antenna with radio frequency (RF) energy source capable of producing the desired field strengths. A set of antennas and multiple RF amplifiers may be required to cover the range of test frequencies. The field is monitored electrically with small probes to ensure proper test levels. To reduce test error, the operation of the DUT is usually monitored by fiber optic couplers.

The following measuring equipment is used:

- field generating device(s) : antenna(s);
- isotropic field probe;
- AN(s);
- HF generator with internal (or external) modulation capabilities;
- High power amplifier;
- Powermeter (or equivalent measuring instrument) to measure forward power and reflected power.

6.1 Field Generating Device

The field generating device shall be an antenna. Any available antenna (including high power baluns if appropriate) which is capable of radiating the specified field strength at the DUT with the available power may be used.

The construction and orientation of any field generating device shall be such that the generated field can be polarized in the mode specified in the test plan.

6.2 Field Probes

Field probes should be electrically small and isotropic. The transmission lines from the probes should be either fiber optic links or very high resistance.

6.3 Stimulation and Monitoring of the DUT

The DUT shall be operated as required in the test plan by actuators which have a minimum effect on the electromagnetic characteristics, e.g. plastic blocks on the push-buttons, pneumatic actuators with plastic tubes.

Connections to equipment monitoring electromagnetic interference reactions of the DUT may be accomplished by using fiber optics, or high resistance leads. Other type of leads may be used but require extreme care to minimize interactions. The orientation, length and location of such leads shall be carefully documented to ensure repeatability of test results.

Any electrical connection of monitoring equipment to the DUT may cause malfunctions of the DUT. Extreme care shall be taken to avoid such an effect.

7. Test Set-Up – Test Performed with a Ground Plane

7.1 Ground Plane

The ground plane shall be made of 0.5 mm thick (minimum) copper, brass or galvanized steel.

The minimum width of the ground plane shall be 1000 mm. The minimum length of the ground plane shall be 2000 mm, or underneath the entire equipment plus 200 mm, whichever is larger.

The height of the ground plane (test bench) shall be (900 ± 100) mm above the floor. The ground plane shall be bonded to the shielded enclosure such that the D.C. resistance shall not exceed 2.5 m Ω . In addition, the bond straps shall be placed at a distance no greater than 0.3 m apart.

7.2 Power Supply and Artificial Network

Each DUT power supply lead shall be connected to the power supply through an artificial network.

Power supply is assumed to be negative ground. If the DUT utilizes a positive ground then the test set-ups shown in the figures need to be adapted accordingly. Power shall be applied to the DUT via 5 μ H / 50 Ω artificial network (see annex A for artificial network schematic). Depending on the intended DUT installation in the vehicle:

- DUT remotely grounded (vehicle power return line longer than 200 mm): two artificial networks are required, one for the positive supply line and one for the power return line (see Appendix B);
- DUT locally grounded (vehicle power return line 200 mm or shorter): one artificial network is required, for the positive supply (see Appendix B).

The AN(s) shall be mounted directly on the ground plane. The case(s) of the AN(s) shall be bonded to the ground plane.

The power supply return shall be connected to the ground plane (between the power supply and the AN(s))

The measuring port of each AN shall be terminated with a 50 Ω load.

7.3 Location of the DUT

The DUT shall be placed on a non-conductive, low relative permittivity (dielectric constant) material ($\epsilon_r \leq 1.4$), at (50 ± 5) mm above the ground plane.

The case of the DUT shall not be grounded to the ground plane unless it is intended to simulate the actual vehicle configuration.

- The face of the DUT shall be located at a distance of (200 ± 10) mm from the edge of the ground plane.

7.4 Location of the Test Harness

The length of test harness parallel to the front edge of the ground plane shall be (1500 ± 75) mm.

The total length of the test harness between the DUT and the AN (or the RF boundary) shall not exceed 2000 mm. The wiring type is defined by the actual system application and requirement.

The test harness shall be placed on a non-conductive, low relative permittivity (dielectric constant) material ($\epsilon_r \leq 1.4$), at (50 ± 5) mm above the ground plane.

The length of test harness parallel to the front edge of the ground plane shall be located at a distance of (100 ± 10) mm from the edge of the ground plane.

7.5 Location of the Load Simulator

Preferably, the load simulator shall be placed directly on the ground plane. If the load simulator has a metallic case, this case shall be bonded to the ground plane.

Alternatively, the load simulator may be located adjacent to the ground plane (with the case of the load simulator bonded to the ground plane) or outside of the test chamber, provided the test harness from the DUT passes through an RF boundary bonded to the ground plane.

When the load simulator is located on the ground plane, the DC power supply lines of the load simulator shall be connected through the AN(s).

7.6 Location of the Field Generating Device (Antenna)

The height of the phase center of the antenna shall be (100 ± 10) mm above the ground plane.

No part of any antenna radiating element shall be closer than 250 mm to the floor. The radiating elements of the antenna shall not be closer than 500 mm to any absorber material, and shall not be closer than 1500 mm to the walls or ceiling of the shielded enclosure.

The distance between the wiring harness and the antenna shall be (1000 ± 10) mm. This distance is measured from:

- the phase center (mid-point) of the biconical antenna; or
- the nearest part of the log-periodic antenna; or
- the nearest part of the horn antenna.

The phase center of the antenna for frequencies from 80 MHz to 1000 MHz shall be in line with the center of the longitudinal part (1500 mm length) of the wiring harness.

The phase center of the antenna for frequencies above 1000 MHz shall be in line with the DUT.

Examples of test configurations are shown in Figures 1 to 3.

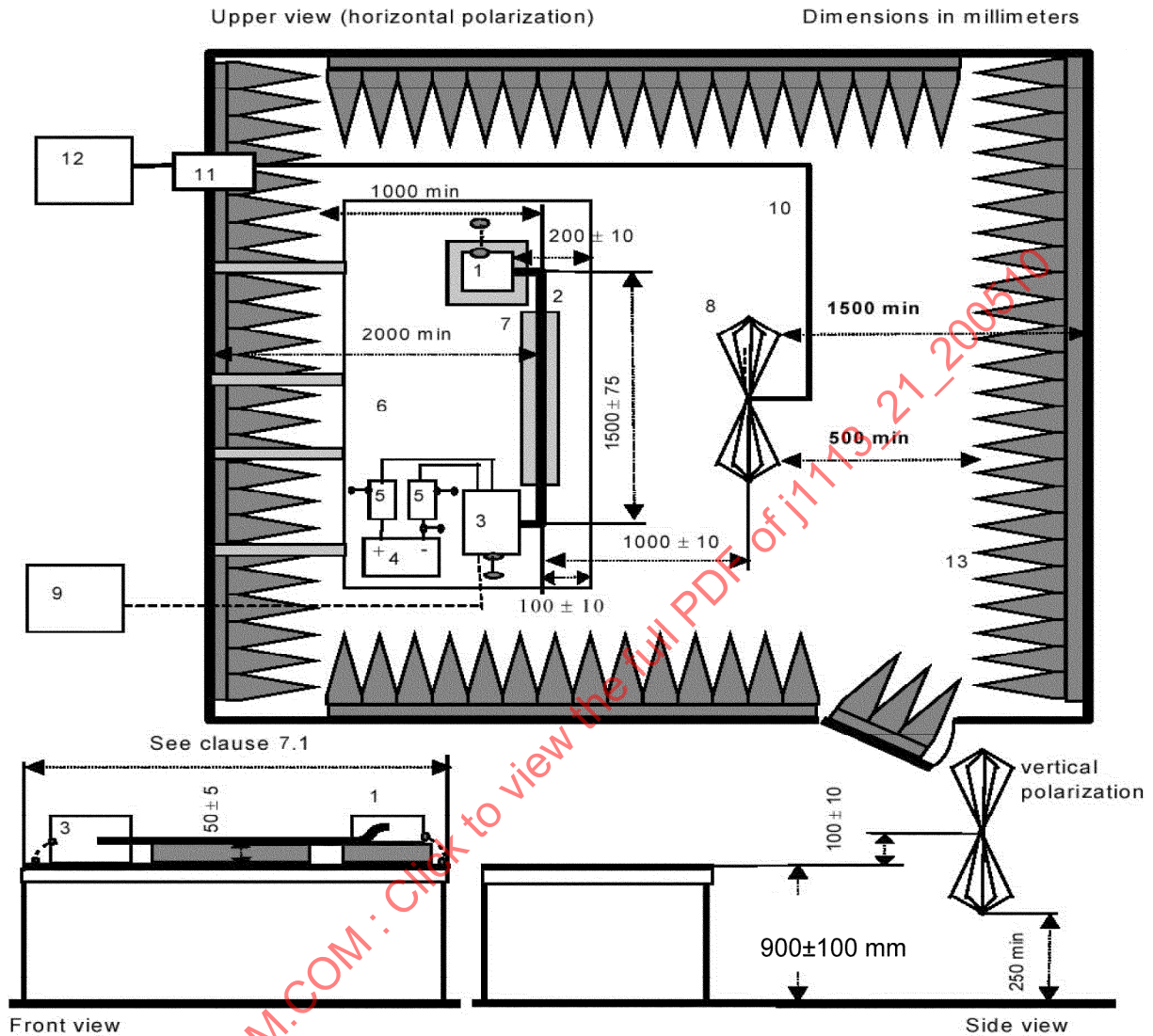

Key

- | | |
|---|--|
| 1 DUT (grounded locally if required in test plan) | 8 Biconical antenna |
| 2 Test harness | 9 Stimulation and monitoring system |
| 3 Load simulator (placement and ground connection according to 7.5) | 10 High quality double-shielded coaxial cable (50 Ω) |
| 4 Power supply (location optional) | 11 Bulkhead connector |
| 5 Artificial network (AN) | 12 RF signal generator and amplifier |
| 6 Ground plane (bonded to shielded enclosure) | 13 RF absorber material |
| 7 Low relative permittivity support ($\epsilon_r \leq 1.4$) | |

FIGURE 1—EXAMPLE OF TEST SET-UP – BICONICAL ANTENNA

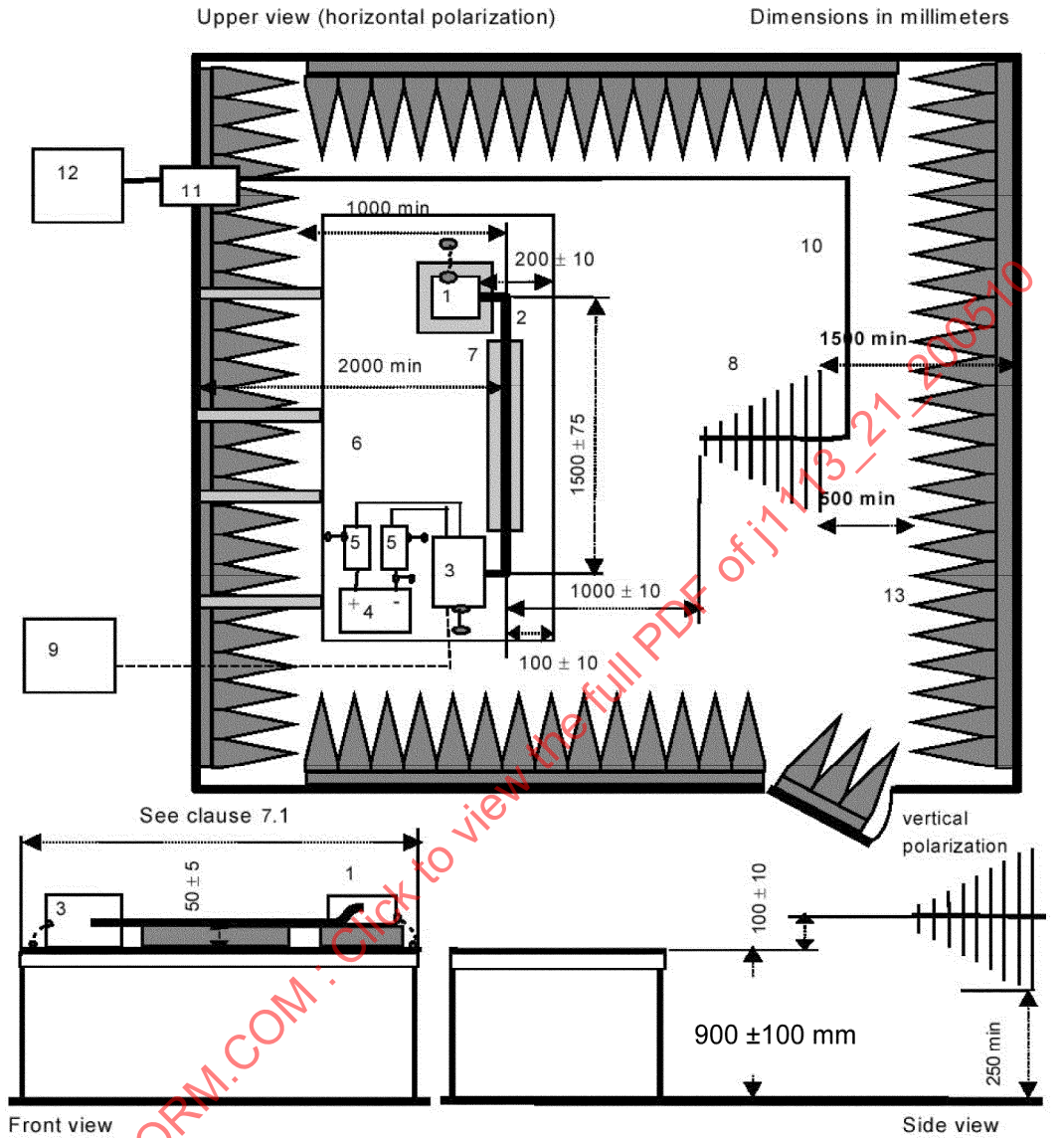

Key

- | | |
|---|--|
| 1 DUT (grounded locally if required in test plan) | 8 Log-periodic antenna |
| 2 Test harness | 9 Stimulation and monitoring system |
| 3 Load simulator (placement and ground connection according to 7.5) | 10 High quality double-shielded coaxial cable (50 Ω) |
| 4 Power supply (location optional) | 11 Bulkhead connector |
| 5 Artificial network (AN) | 12 RF signal generator and amplifier |
| 6 Ground plane (bonded to shielded enclosure) | 13 RF absorber material |
| 7 Low relative permittivity support ($\epsilon_r \leq 1.4$) | |

FIGURE 2—EXAMPLE OF TEST SET-UP – LOG-PERIODIC-ANTENNA

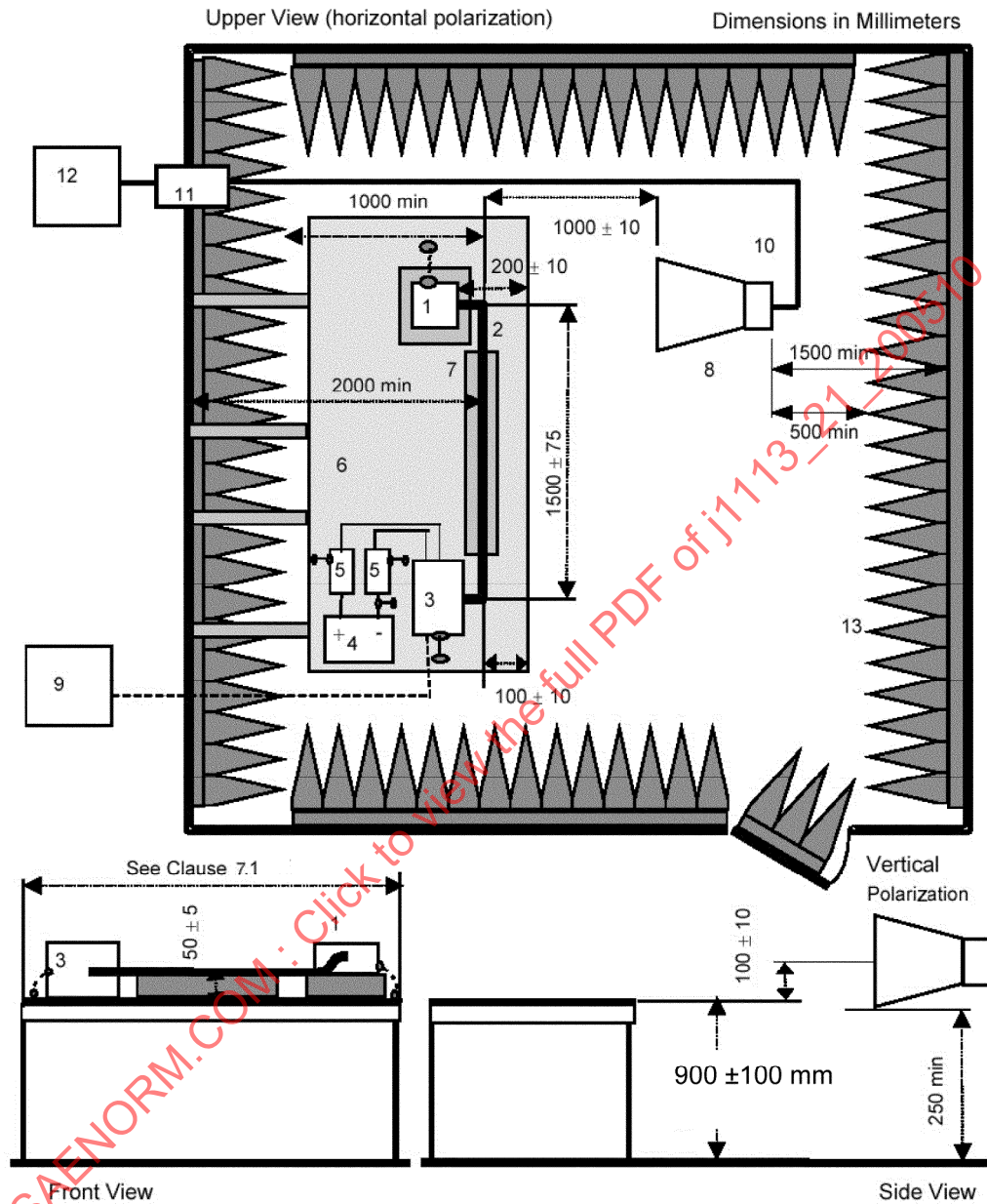

Key

- | | |
|---|--|
| 1 DUT (grounded locally if required in test plan) | 8 Horn antenna |
| 2 Test harness | 9 Stimulation and monitoring system |
| 3 Load simulator (placement and ground connection according to 7.5) | 10 High quality double-shielded coaxial cable (50 Ω) |
| 4 Power supply (location optional) | 11 Bulkhead connector |
| 5 Artificial network (AN) | 12 RF signal generator and amplifier |
| 6 Ground plane (bonded to shielded enclosure) | 13 RF absorber material |
| 7 Low relative permittivity support ($\epsilon_r \leq 1.4$) | |

FIGURE 3—EXAMPLE OF TEST SET-UP FOR FREQUENCIES ABOVE 1 GHz – HORN ANTENNA

8. Test Setup – Test Performed without Ground Plane

8.1 Test Configuration

The DUT shall be subjected to radiated immunity testing using an antenna for field generation without ground plane. For a schematic diagram of the test setup refer to Figure 4.

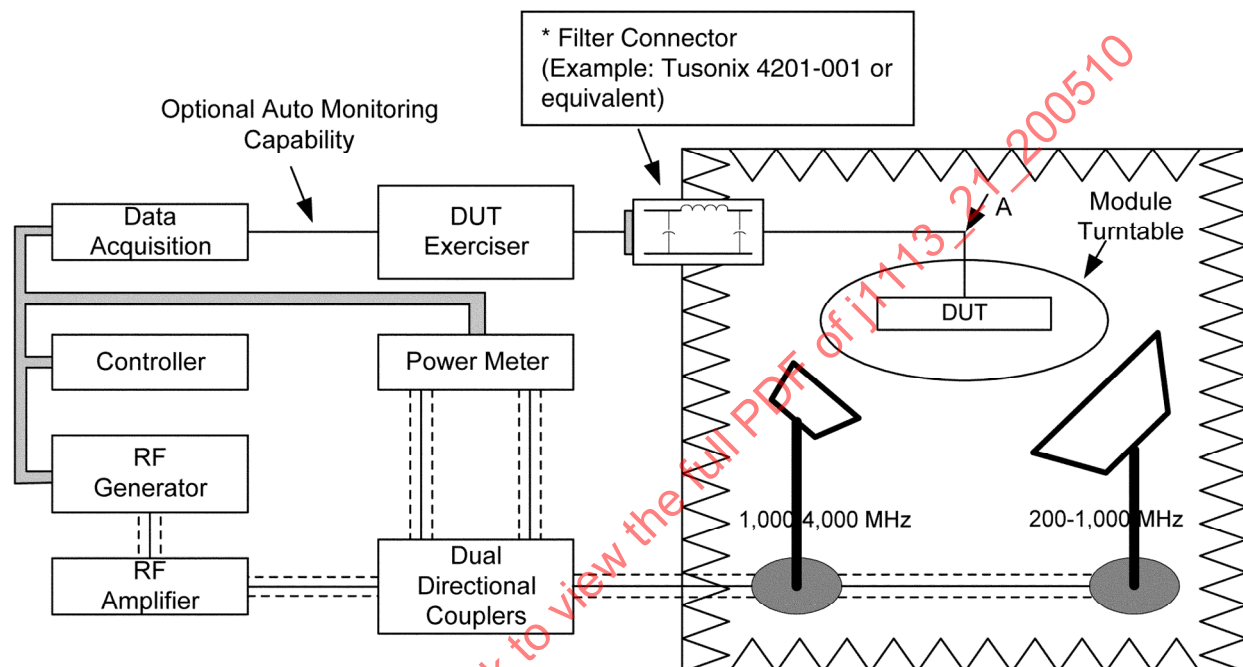

FIGURE 4—RADIATED IMMUNITY TEST IN AN ALSE WITHOUT A GROUND PLANE

* NOTE—The DUT exerciser or load simulator can be located either inside or outside of the ALSE. If it is located outside of the ALSE, lines must be filtered as shown in Figure 4.

Use substitution method with forward power and specified field uniformity.

The antenna shall be sighted on the DUT

DUT to point "A" is an unshielded wiring harness of 600 ± 50 mm in length.

From point "A", the harness goes vertically 1 meter to the floor and along the floor to the wall bulkhead feed-through filter.

The DUT shall be 1 meter above the floor.

The DUT shall be a minimum of 1 meter from the antenna and any other conductive surface and a minimum of 1 meter from any absorber.

Vertical polarization shall be used.

The DUT shall be tested in three mutually perpendicular orientations (principal planes): (i) with the main circuit board in the DUT parallel to the chamber floor (vehicle mounting surface down), (ii) with the main circuit board perpendicular to the chamber floor edge on to the antenna and (iii) with the main circuit board perpendicular to the chamber floor and broadside to the antenna. These three orientations shall be chosen from the six possible orthogonal orientations, to allow visibility of the DUT, if required, and to maintain a consistent and repeatable routing of the DUT harness and direct exposure of DUT apertures to the antenna.

- For modules in a metal case, the DUT connector(s) should be orientated upward or toward the antenna.
- Wiring harness routing shall be controlled and documented.

8.2 Field Uniformity Measurement

Define a 0.5x1.0 meter rectangle area on the vertical plane as shown in Figure 5. The uniformity calculations are based on measured electric field strength (V/m) at each point (e.g. a1, b1, c1) which is perpendicular to the active antenna. The reference point is at point c3. The uniformity (in dB) shall be calculated by using the following equation:

$$20 * \log (E_{\text{test point}} / E_{\text{ref}}) \quad (\text{Eq. 1})$$

Where:

$E_{\text{test point}}$ = Measured electric field strength in (V/m) at the test point

E_{ref} = Measured electric field strength in (V/m) at the reference point c3

The calculated uniformity shall be within +3 /-6 dB to point c3. There is no requirement for the two top corner areas. The reference RF field probe shall be placed at its isotropic angle toward to the transmit antenna. All specified physical dimensions in Figure 5 shall have a tolerance of $\pm 10\%$.

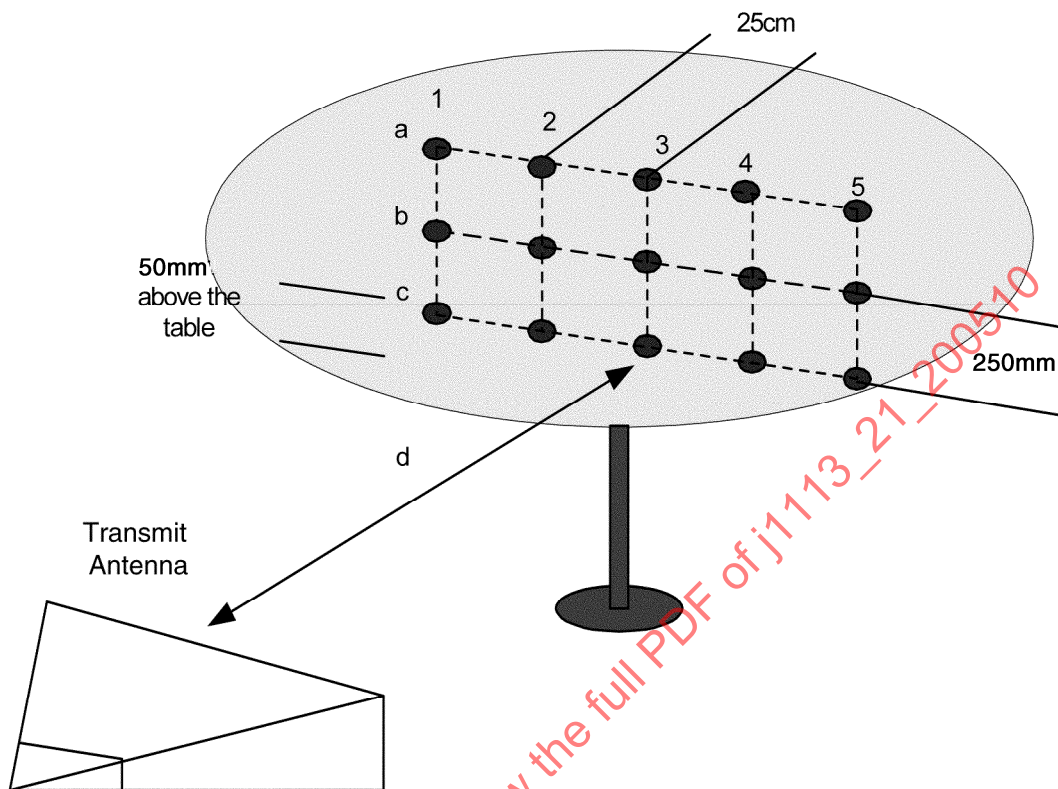

FIGURE 5—FIELD UNIFORMITY MEASUREMENT FOR TEST PERFORMED ON BENCH TOP WITHOUT GROUND PLANE

9. Test Procedure

The general arrangement of the disturbance source and connecting harnesses etc. represents a standardized test condition. Any deviations from the standard test harness length etc. shall be agreed upon prior to testing and recorded in the test report.

The DUT shall be made to operate under typical loading and other conditions as in the vehicle. These operating conditions must be clearly defined in the test plan to ensure supplier and customer are performing identical tests.

The orientation(s) of the DUT for radiated immunity tests shall be defined in the test plan.

For measurements performed with the ground plane, the following polarizations are recommended:

- From 400 MHz to 18 GHz measurements shall be performed in horizontal polarization.
- From 30 MHz to 18 GHz measurements shall be performed in vertical polarization.

For measurements performed without the ground plane, see clause 8.1.

9.1 Test Plan

Prior to performing the tests, a test plan shall be generated which shall include:

- test set-up;
- frequency range;
- DUT mode of operation;
- DUT acceptance criteria;
- test severity levels;
- DUT monitoring conditions;
- antenna location;
- test report content;

and any special instructions and changes from the standard test.

Every DUT shall be tested under the most significant conditions, i.e at least in stand-by mode and in a mode where all the actuators can be excited

9.2 Test Method

CAUTION—Hazardous voltages and fields may exist within the test area. Take care to ensure that the requirements for limiting the exposure of humans to RF energy are met.

The substitution method is based upon the use of forward power as the reference parameter used for field calibration and test.

The test shall be performed with the substitution method.

This method is performed in two phases:

- field calibration (without the DUT present);
- test of the DUT.

The RF power required to achieve the required field strength is determined during the field calibration phase.

9.2.1 FIELD CHARACTERIZATION

The specific test level (field) shall be characterized periodically by recording the corresponding forward power (reversed power shall also be recorded for documentation purposes) required to produce a specific field strength (measured with a field probe) for each test frequency

This characterization shall be performed with an un-modulated sinusoidal wave.

The electrical phase center of the field probe should be placed (150 ± 10) mm above the ground plane and at a distance of (100 ± 10) mm from the front edge of the ground plane.

For frequencies from 30 MHz to 1000 MHz the phase center of the field probe shall be in line with the center of the longitudinal part (1500 mm length) of the wiring harness position.

For frequencies above 1000 MHz the phase center of the field probe shall be in line with the DUT position.

The field generating device (antenna) shall be placed at a distance of (1000 ± 10) mm from the electrical phase center of the field probe.

The field strength shall be characterized for vertical and horizontal polarizations.

When requested, the values of forward and reverse power recorded in the data file and a precise description of the associated position of the field probe shall be included in the test report.

9.2.2 DUT TEST

The DUT, harness and associated equipment are installed on the test bench as described in clause 7.

The test is conducted by subjecting the DUT to the test signal based on the characterized value as predetermined in the test plan.

If possible, load box and simulator should be placed outside of the chamber during test to avoid potential interference. All supply lines between the load box/simulator and the DUT shall be filtered.

NOTE—A field probe may be placed above the wiring harness during the test.

The tests shall be performed for horizontal and vertical polarization in the appropriate frequency ranges.

9.3 Test Report

As required in the test plan, a test report shall be submitted detailing information regarding the test equipment, test area, systems tested, frequencies, power levels, system interactions and any other relevant information regarding the test.

10. Notes

10.1 Marginal Indicia

The change bar (I) located in the left margin is for the convenience of the user in locating areas where technical revisions have been made to the previous issue of the report. An (R) symbol to the left of the document title indicates a complete revision of the report.

**APPENDIX A
(INFORMATIVE)
ARTIFICIAL NETWORK (AN)**

A.1 General

The AN is used as a reference standard in the laboratory in place of the impedance of the vehicle wiring harness in order to determine the behavior of equipment and electrical and electronic devices. It shall be able to withstand a continuous load corresponding to the requirements of the DUT.

The AN schematic is shown in Figure A1.

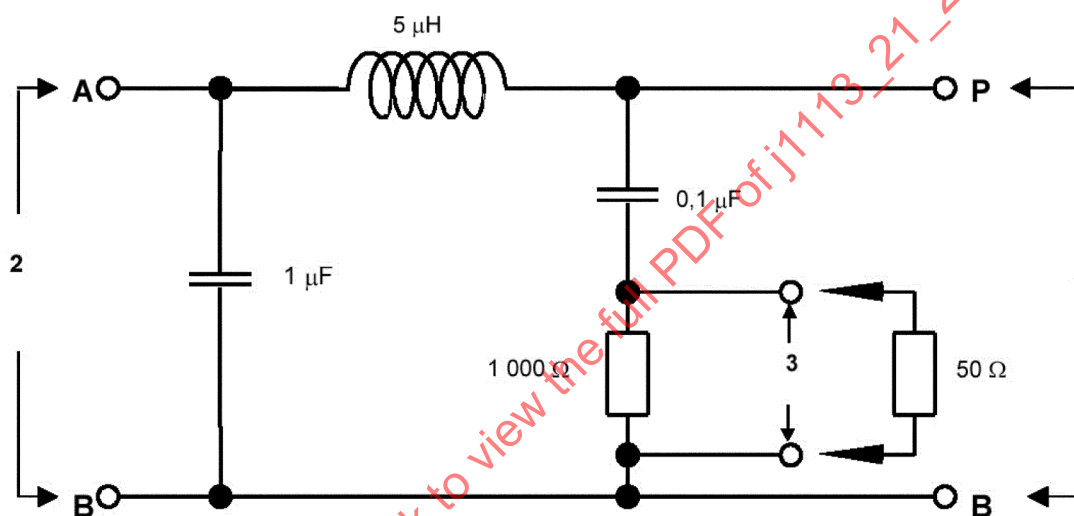

FIGURE A1—EXAMPLE OF AN SCHEMATIC

A.2 AN Impedance

The AN impedance $|Z_{PB}| \Omega$ (tolerance $\pm 20\%$) in the measurement frequency range of 0.1 MHz to 100 MHz assuming ideal electrical components is shown in Figure D2. It is measured between the terminals P and B ("1" of Figure A1) with a 50Ω load on the measurement port ("3" of Figure A1) and with terminals A and B ("2" of Figure A1) short circuited.

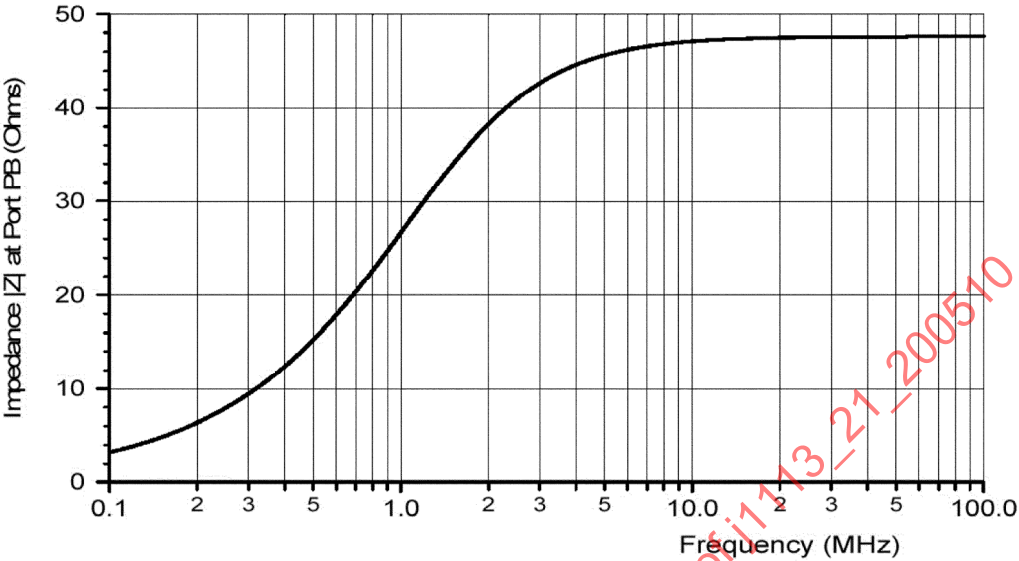

FIGURE A2—CHARACTERISTICS OF THE AN IMPEDANCE
|Z PB | FROM 0.1 MHz TO 100 MHz